

# KVADRO

Design T. Colzani

LIBRERIA | BOOKCASE

2013



Il sistema componibile KVADRO si sviluppa su contenitori con le seguenti misure: un contenitore singolo, a un'anta (cm. 65xh65) e un contenitore doppio, a due ante (cm. 130xh65). Gli elementi a una e due ante sono disponibili con frontale in legno o in cristallo fumé. L'interno dei contenitori è in acero canadese. Una volta stabilito il numero dei contenitori è necessario apporre una spalla per ciascun fianco e un top di finitura.

*The system KVADRO works on modules with different measures: a simple container with one door (cm. 65xh65) and a double container with two doors (cm. 130xh65). Both one and two doors modules are available in wood or in smoked glass. The interior of the container is in Canadian maple. Once the number of containers to be used have been decided it is necessary to select the tops and sides in order to complete the unit.*

*Das System KVADRO besteht aus Modulen mit verschiedenen Maßen: einen Modul mit einer Tür (cm.65xh65) und einen Doppelmodul mit zwei Türen (cm. 130xh65). Beiden Module mit ein oder zwei Türen sind aus Holz oder aus Rauch-Glas verfügbar. Das Innere des Module ist aus Kanadisch Ahorn. Sobald die Anzahl der Module bestimmt wird, muss die Platte und Seitenteile ergänzt werden, um die Komposition zu komplettieren.*

*Le système KVADRO travaille sur modules avec mesures différentes: un container simple avec une porte (cm.65xh65) et un container double avec deux portes (cm.130xh65). Tous les deux containers à une ou deux portes sont disponibles en bois ou en verre fumé. Intérieur du container en érable Canadien. Une fois établi le nombre des containers à utiliser, on doit sélectionner les plateaux et les côtés, afin de compléter la composition.*

*El sistema modular KVADRO se desarrolla sobre unos módulos cuadrados con las siguientes medidas: un contenedor individual con una puerta (cm. 65xh.65) y un contenedor doble con dos puertas (cm. 130xh65). Los elementos con una o dos puertas son disponibles con frontal en madera o en cristal ahumado. Interior del contenedor en arce canadiense. Una vez establecido el número de contenedores es necesario considerar un elemento de cierre lateral para cada lado y una tapa de cierre.*



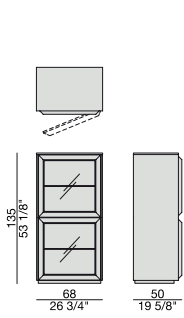

COMP.A

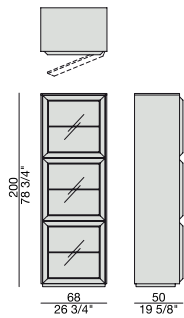

COMP.B

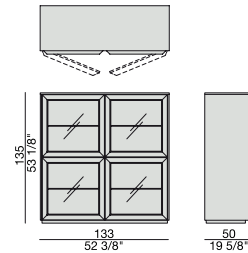

COMP.C

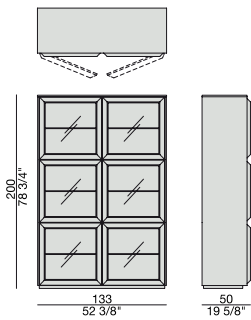

COMP.D

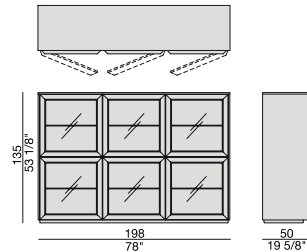

COMP.E

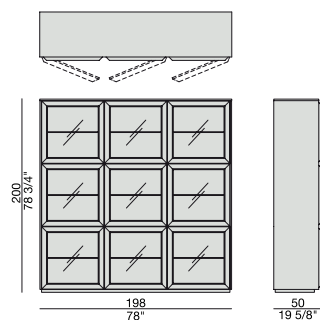

COMP.F

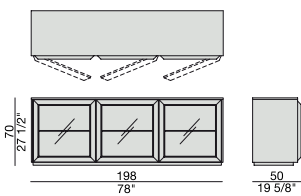

COMP.G

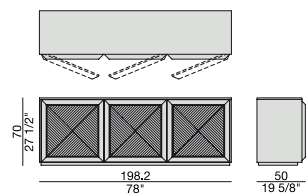

COMP.H

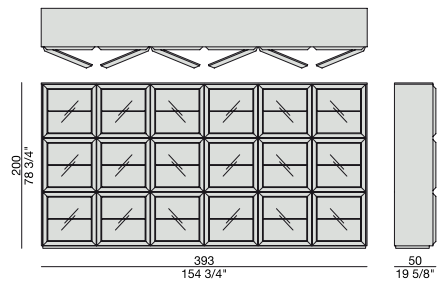

COMP.R

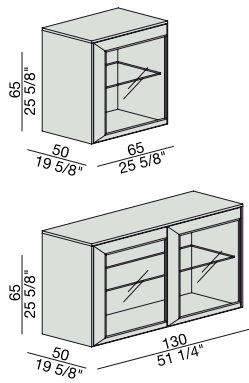

CONTENITORE CRISTALLO  
Glass container

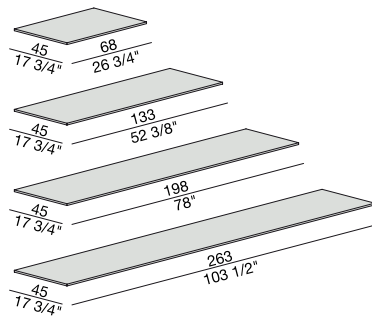

PIANO DI CHIUSURA  
Top

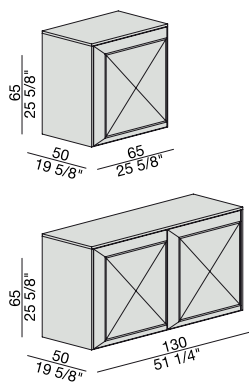

CONTENITORE LEGNO  
Wood container

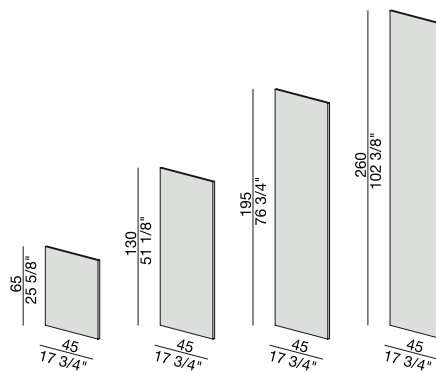

SPALLA  
Side

**Essenze | Wood**

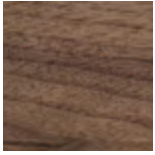

Noce canaletta  
Canaletta walnut

**Cristallo | Glass**



Fumé  
Smoked